

Kast Inclusief:
 DUO hevel
 type plaatje voor contactgegevens
 C-rail t.b.v. bevestiging CAM module 1x10A zonder meter

D				GETEKEND	28-11-2023	RF	TITEL	
C	update tekeningen	20-6-2024	RF	CONTROLE	28-11-2023	RF	Hoofdsamenstelling	
B	aardrail + c-rail	7-2-2024	RF	AMERIKAANSE PROJECTIE		SCHAAL	PRODUCT-TYPE	
A	Update model	11-1-2024	RF			1:10	RL400CAM	
REV	OMSCHRIJVING	DATUM	NAAM				TEKENINGNR.	
Tolerantie tenzij anders aangegeven : ±0.5 mm/ ±0.5° Tolerantie laser snijden : ±0.1 mm Lasnorm vlg. ISO 2553 Alg. a=2 Daar elke toepassing gebaseerd is op de ter plaatse geldende omstandigheden, kunnen aan de gegeven constructies en tekeningen geen rechten worden ontleend.				Innovatiepark 16 NL-4906 AA Oosterhout Tel:31 162 468950 Fax:31 162 431132			20230555	
							KLANT	Staka
							BLAD	1 van 5

Kast ongediertevrij te houden door bijv. fundatiekorrels of wartelplaten te gebruiken.

Afmetingen C-rail

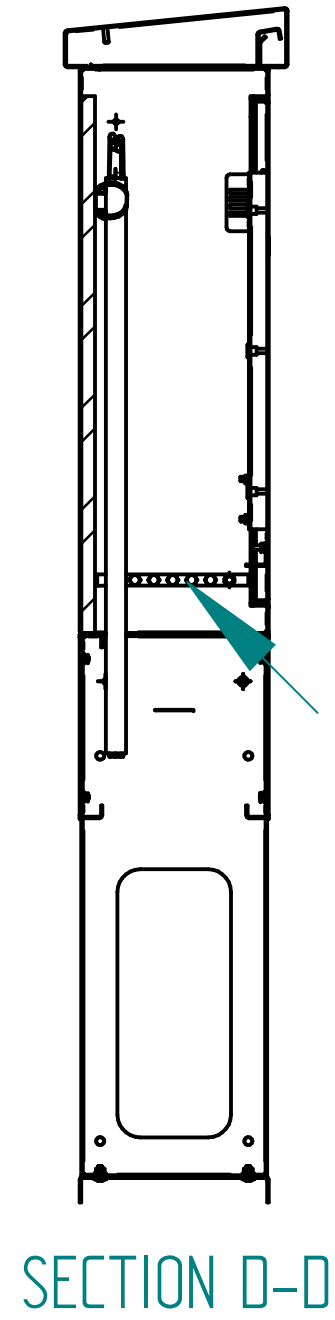
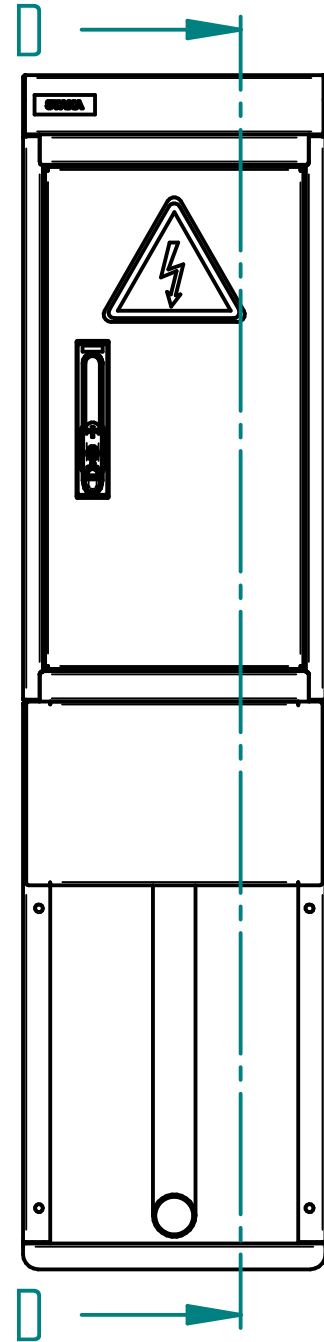

Aardrail

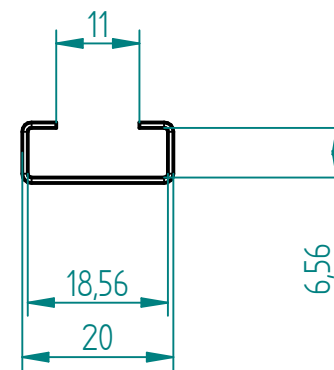
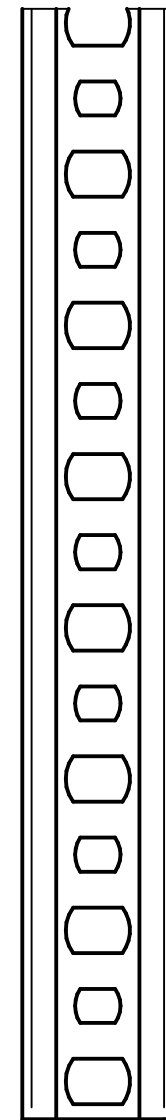

D				GETEKEND	28-11-2023	RF	TITEL	
C	update tekeningen	20-6-2024	RF	CONTROLE	28-11-2023	RF	aardrail	
B	aardrail + c-rail	7-2-2024	RF	AMERIKAANSE PROJECTIE		SCHAAL	PRODUCT-TYPE	
A	Update model	11-1-2024	RF			5:1	RL400CAM	
REV	OMSCHRIJVING	DATUM	NAAM				TEKENINGNR.	
Tolerantie tenzij anders aangegeven : ±0.5 mm/ ±0.5° Tolerantie laser snijden : ±0.1 mm Lasnorm vlg. ISO 2553 Alg. a=2				Innovatiepark 16 NL-4906 AA Oosterhout Tel:31 162 468950 Fax:31 162 431132			20230555	
Daar elke toepassing gebaseerd is op de ter plaatse geldende omstandigheden, kunnen aan de gegeven constructies en tekeningen geen rechten worden ontleend.				STAKA			KLANT	Staka
							BLAD	2 van 5

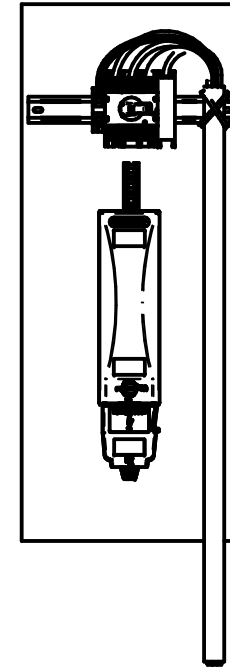
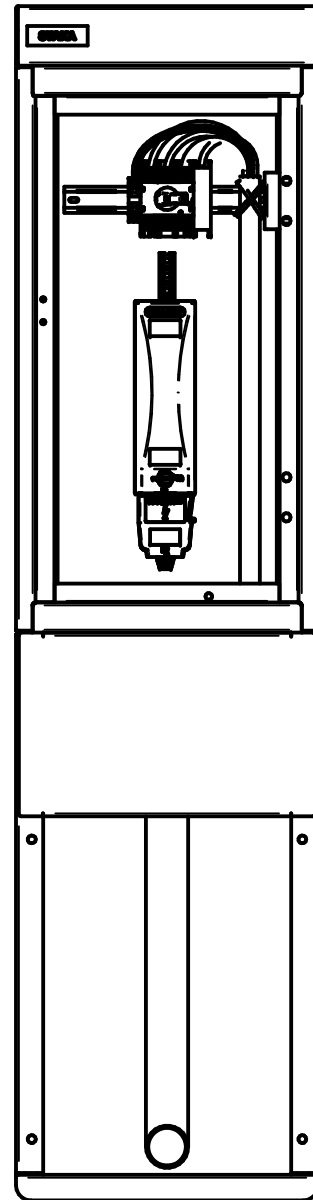

D				GETEKEND	28-11-2023	RF	TITEL	
C	update tekeningen	20-6-2024	RF	CONTROLE	28-11-2023	RF	Inhoud zuil	
B	aardrail + c-rail	7-2-2024	RF	AMERIKAANSE PROJECTIE		SCHAAL	PRODUCT-TYPE	
A	Update model	11-1-2024	RF			1:1	RL400CAM	
REV	OMSCHRIJVING	DATUM	NAAM				TEKENINGNR.	
Tolerantie tenzij anders aangegeven : ±0.5 mm/ ±0.5° Tolerantie laser snijden : ±0.1 mm Lasnorm vlg. ISO 2553 Alg. a=2 Daar elke toepassing gebaseerd is op de ter plaatse geldende omstandigheden, kunnen aan de gegeven constructies en tekeningen geen rechten worden ontleend.				Innovatiepark 16 NL-4906 AA Oosterhout Tel:31 162 468950 Fax:31 162 431132			20230555	
							KLANT	Staka
							BLAD	3 van 5